



蓝巨人塑业产品手册(2020版)

# BLUE GIANT

PRODUCT MANUAL

[产品手册-安护系列]



江苏蓝巨人塑业有限公司  
Jiangsu Blue Giant Plastic Co.,Ltd

总部 江苏省南京市江宁区营宁路9号  
电话 025-84170862  
传真 025-84175609  
网址 www.ljrjs.com  
邮箱 ljrjsnj@163.com

用品质提升品牌价值  
www.ljrjs.com

## 公司简介

>>COMPANY PROFILE

江苏蓝巨人塑业有限公司源于上个世纪90年代，由原江宁上峰塑料厂重组而成，公司位于六朝古都南京市东郊汤山工业集中区。是一家从事塑料箱盒系列、安护系列产品的研发、设计、制造、营销的创新型企业。专业为电商、医药、食品、服装、汽车、机械、化工等行业的仓储物流系统提供优质的塑料物流器具，以及定制化服务。

我们特别注重产品的品质及实用功能，倡导环保经营，坚持使用100%塑料原料。为进一步实现品牌战略，我们一直笃守以品质提升品牌价值为经营理念，以追求客户最佳满意度为目标，蓝巨人将用实际行动去践行自己的愿景：成为最值得信赖和尊重的公司！

Jiangsu Blue Giant Plastic Co., Ltd originated in the 1990s , reorganized from the former Jiangning Shangfeng plastic factory, located in the ancient capital---Nanjing. We are an innovative enterprise specializing in the design, research and development, manufacturing and marketing of plastic protector , folding boxes, high-rise warehouse storage boxes, spare parts boxes, logistics boxes, plastic pallets and other products.

We have accumulated more than 20 years of experience in the production of plastic products, and have the right to import and export. We have fully served the domestic automotive, pharmaceutical, e-commerce, fast-moving retail, logistics and distribution, food, textile and garment, chemical and other industries, and also exported to the Middle East, Southeast Asia, South America, Australia and other places.

In order to continue the operation and development, we insist on quality and practicality, advocate environmental protection, and insist on using 100% plastic raw materials for processing. In order to further realize the brand strategy, we always adhere to the business philosophy of improving brand value by quality, and taking honesty and customer satisfaction as our responsibility.

Blue Giant plastic will use our actions to practice our vision: strive to be the most trustworthy and respectful company.

## 企业文化CULTURE

### 公司价值观

- 诚实的与人相处, 尊重他人并且乐于助人;
- 严谨的对待工作, 坚守原则;
- 高效的解决问题, 不抱怨客观条件;
- 团结一致, 拥抱变化, 勇往直前!

### 经营理念

- 用品质提升品牌价值!

### 愿景

- 成为最值得信赖和尊敬的公司, 并让员工获得美好生活!

### 使命

- 致力于用高品质产品服务现代物流链

### Company Value

- Honest, Respect for people, Helpful
- Diligent at work, Stick to principles
- Effective problem solving
- United, courageous, Persistent striving

### Business Philosophy

- Committed to be a leader in plastic industry.

### Mission & Vision

- To be a reliable and professional company in plastic industry, And let employees get a better life!

BLUE GIANT  
GIANT PLASTIC

# SAFETY PROTECTION

## 安全防护系列-立柱防撞护角

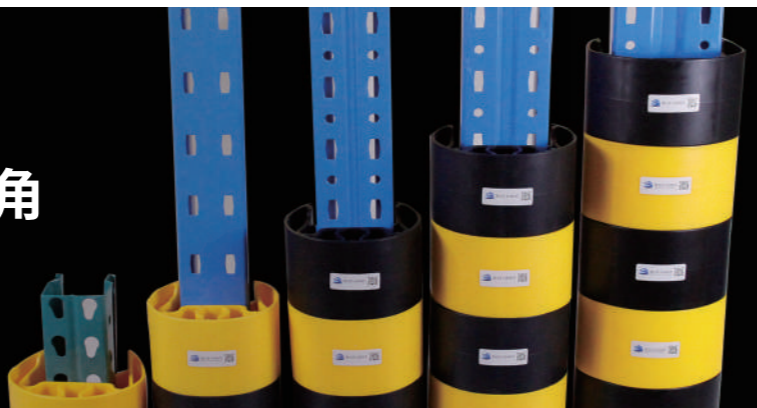

当叉车、搬运车等设备在库房内搬运货物时总会不小心碰撞到货架立柱，轻则划伤掉漆，重则立柱弯曲，造成安全隐患，影响货架的使用寿命和人身安全。蓝巨人自行研制的 **倍坚特®** 牌货架护角就是用来缓冲货架立柱和搬运设备之间冲击力的一种安全防护装置。

### 80-100型适用立柱规格



■ 80



■ 90



■ 100

### 产品介绍 >>> INTRODUCE

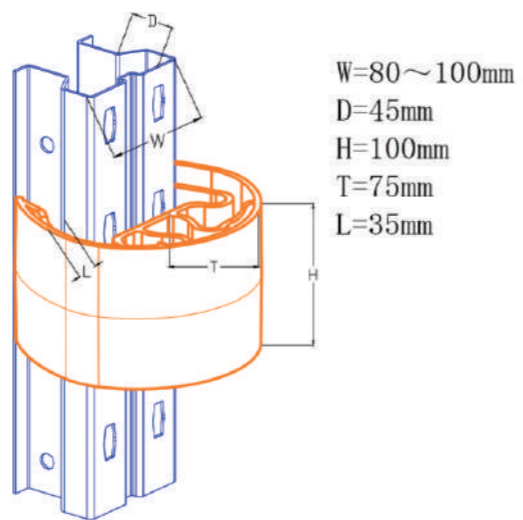
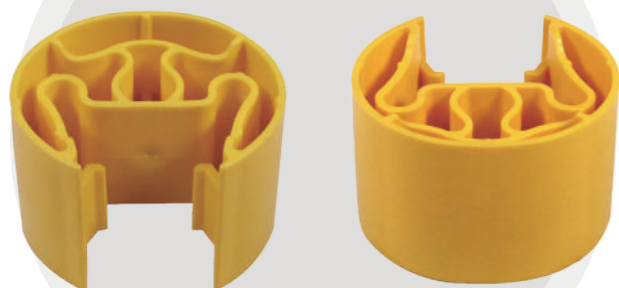

### 产品特点 >>> INTRODUCE

#### 高 端 ▶

黄黑搭配，警示醒目，美观大方，明显提升库房档次。

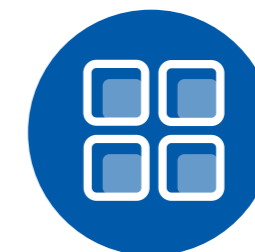

#### ◀ 适 用

使用范围广，两种规格护角能通用国内以及澳洲、欧美等各种款型的货架立柱。

#### 便 捷 ▶

安装简单快速，可徒手安装，同时配备专业安装工具，无需打膨胀螺栓破坏地面。



#### ◀ 安 全

产品采用改性PP料制造，强度高、韧性好、抗冲击、寿命长。不仅可以保护货架立柱，也可以保护叉车、堆高车等搬运设备及人员。

### BGH80~100型

外形尺寸:156x140x100mm  
壁厚:4~6mm  
适用立柱宽度:80~100mm  
外箱尺寸:480x320x520mm  
包装数量:40PCS  
20呎柜装:13440PCS

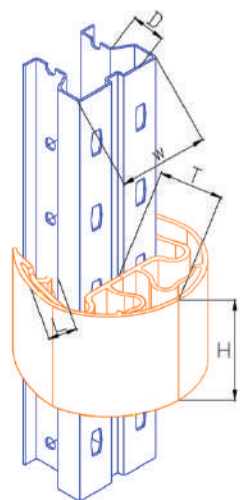
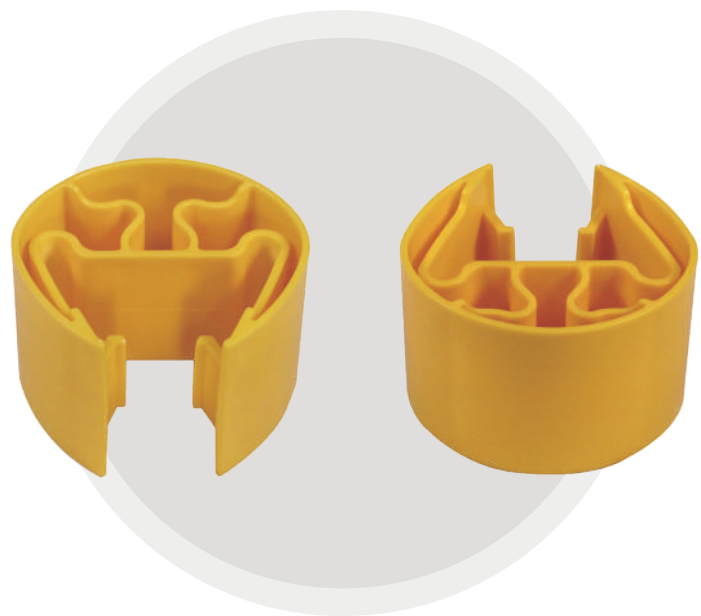

W=75~120mm  
D=45~60mm  
H=100mm  
T=70mm  
L=44mm



■ 安装方便



■ 适用多种立柱

BGH120型

外形尺寸:160x148x100mm  
壁厚:4-6mm  
适用立柱宽度:100~120mm  
外箱尺寸:480x320x520mm  
包装数量:40PCS  
20呎柜装:13440PCS

120型适用立柱规格



■ 76



■ 120

使用场景 >>>  
USAGE SCENARIOS



# SAFETY PROTECTION 安全防护系列-立柱防撞护套

立柱防撞护套是专门为保护钢平台立柱以及建筑物支撑柱而设计的,采用改性LDPE材料吹塑而成,中空结构,双层保护。当立柱受到叉车等设备撞击时,能量被护套缓冲吸收,不仅保护了立柱,也保护了搬运设备。

## 产品特点 >>> INTRODUCE

### 美观醒目 ▶

安全黄色搭配黑色绑带,警示醒目,美观大方,明显提升库房档次。



### 简单适用 ▶

本产品主要适用方形立柱,也可以安装在矩形、圆形等异形立柱上,高度可以是300mm的倍数任意堆叠,损坏可以任意更换。



### 装卸方便 ▶

通常用绑带捆绑即可,也可用螺栓进行双重固定。



### 安全耐用 ▶

采用改性HDPE料制作,强度高,韧性好,抗冲击,耐老化。

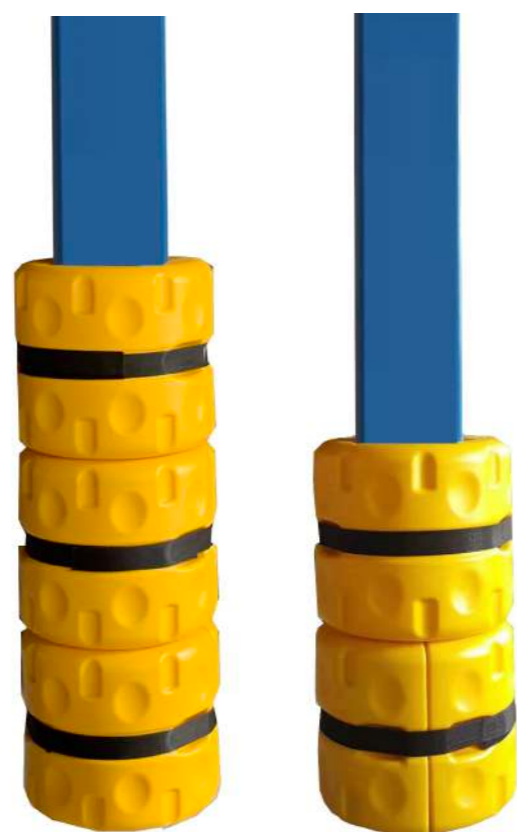

## 产品细节 >>> DETAILS

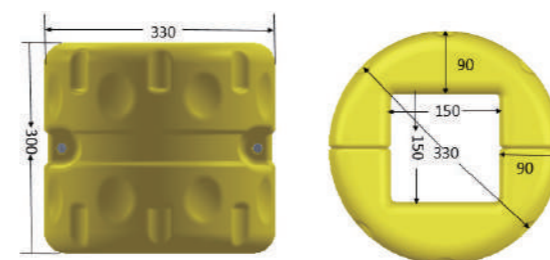
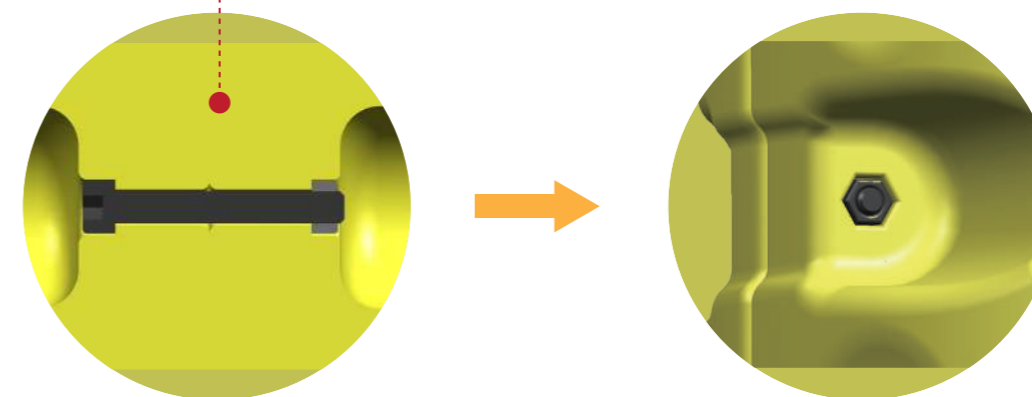
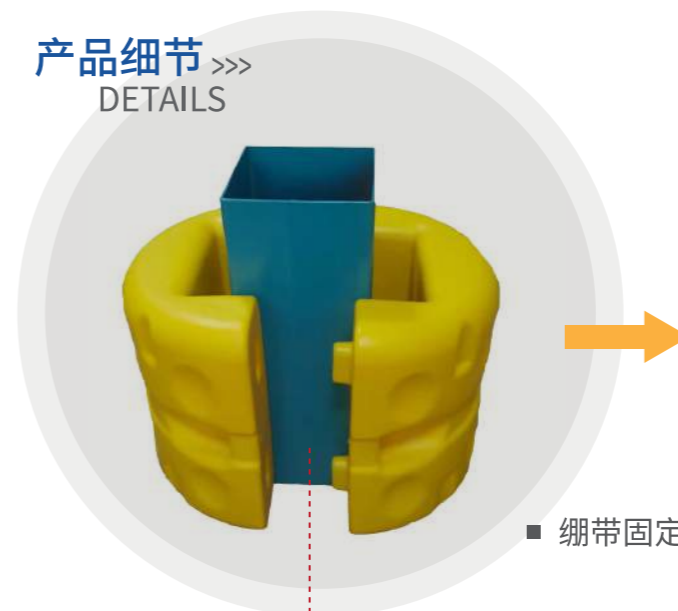

### BGH 150型

外形尺寸:  $\phi 330 \times H300\text{mm}$   
适合立柱: 100~150mm

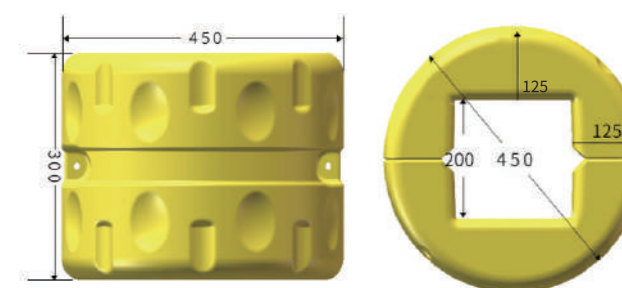

### BGH 200型

外形尺寸:  $\phi 450 \times H300\text{mm}$   
适合立柱: 160~200mm



## SAFETY PROTECTION 安全防护系列-货架防撞护栏

叉车围绕货架的频繁作业不可避免的会撞击到货架的端头，撞击的后果甚至会造成整个库区货架的坍塌，给企业造成设备损毁、停工停产甚至人员伤亡的巨大经济损失。

**倍坚特®** 货架防撞护栏是针对货架末端的安全风险而专门设计的保护系统。产品采用增强聚合塑料制作，有极强的抗冲击性能和柔韧性，具有被撞击后快速恢复原状的特点。

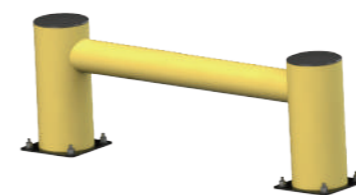
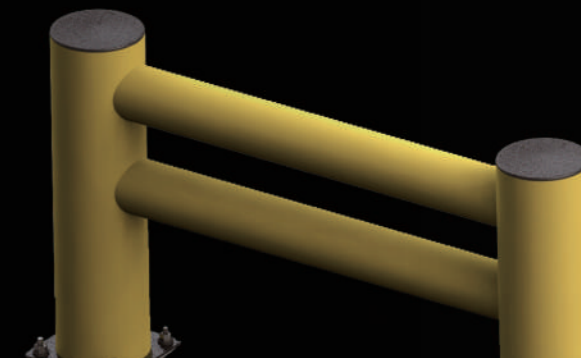

**BGH300-1000**

立柱:φ150 x H350mm  
横梁:φ90 x H300 x L1000mm

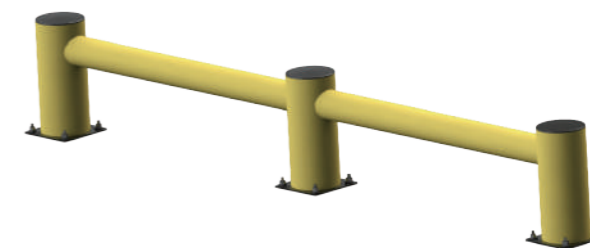

**BGH300-2300**

立柱φ150 x H350mm  
横梁φ90 x H300 x L2300mm

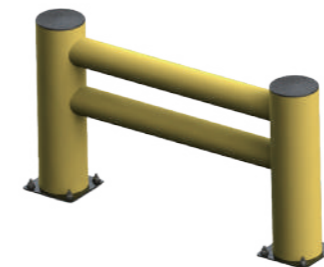

**BGH500-1000**

立柱:φ150 x H550mm  
横梁:φ90 x H500 x L1000mm

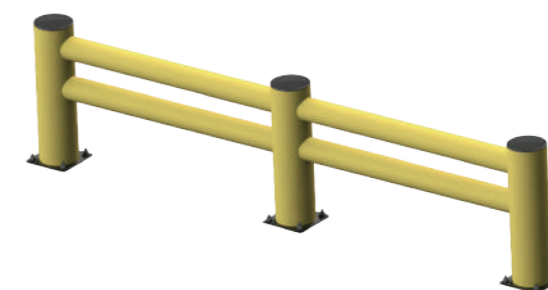

**BGH500-2300**

立柱φ150 x H350mm  
横梁φ90 x H500 x L2300mm

使用场景 >>>  
USAGE SCENARIOS

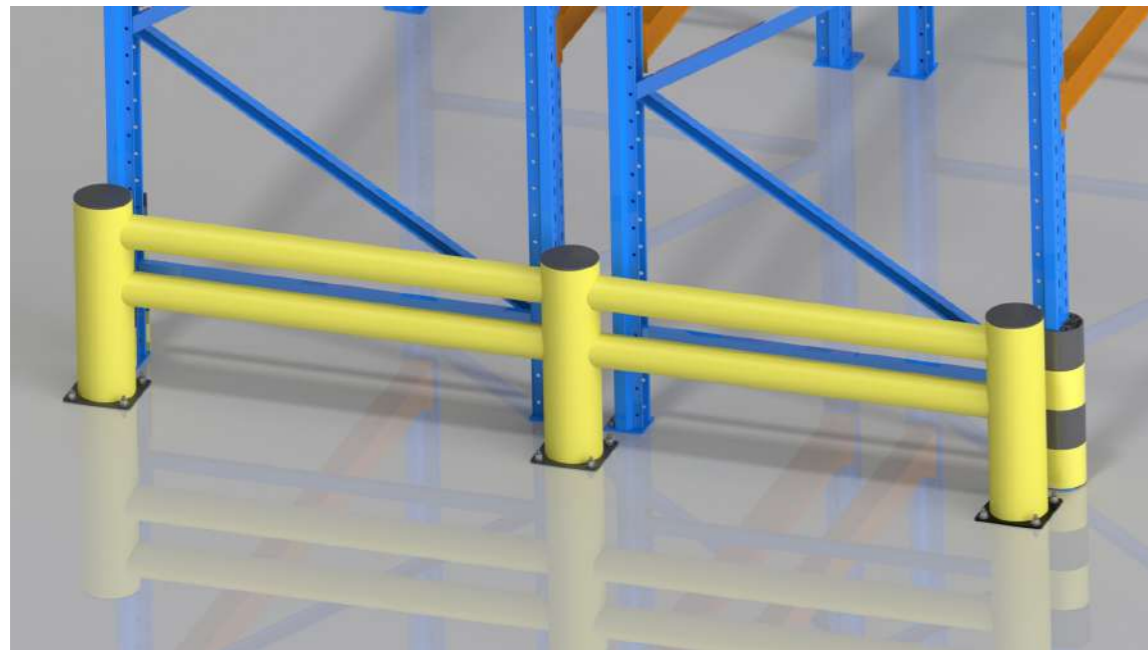
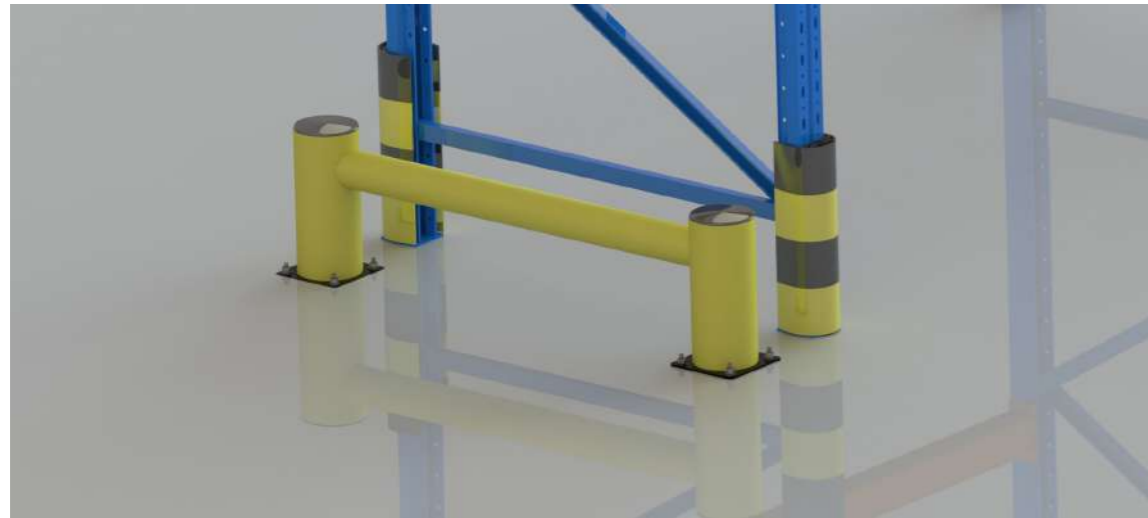

\*长度、高度可定制

材料	性能	密度	防锈、防腐	着色	冲击强度	柔韧性	更换、维护	使用寿命	成本
金属	★★★★★	★★★★★	★★★	★★★	★★★★	★★	★★★★	★★	★★
高分子	★★★★★	★★★★★	★★★★★	★★★★★	★★★★★	★★★★★	★★★★★	★★★★★	★★★★★